



Fixture & Packaging

"Quality Store Fixtures"

**Shipping &
Installations
Nationwide!**

*Hundreds of satisfied
customers nationwide*

Stock Wireless Program



Innovative • Stylish • Affordable

Headquarters & Showroom

6975 Commerce Ave
El Paso, TX 79915
(915) 779-3726

Branch Showroom

1020 Ash St
McAllen, TX 78501
(956) 630-2250

888-806-3726
www.ramfixture.com

ACTIVATION CENTERS

Pictured unit includes:
 • (1) ADA/Desk Wing (W-ADA),
 • (2) Activation Counter with Top Ledge (W-S2R),
 • (1) Showcase (W-3SS)
Only \$1322⁰⁰



(B) (A) (C) (A)



Back View

(A) Activation Counter with Top Ledge

Dimensions: 32¹/₂"L x 23"D x 43¹/₂"H. Features: This sturdy register stand has a top mounted service surface ledge with indentation for Monitor/Screen making it compact yet fully functional. It includes openings for wire management, one adjustable shelf, and a 7¹/₄" register drop.

W-S2R \$377.00

(B) ADA/Desk Wing

Dimensions: 36"L x 19"D x 29"H. Features: Meets American's with Disabilities Act requirements. Ideal area for customers to sit for new activations or customer service issues.

W-ADA \$179.00



Only \$1234⁰⁰
 Components pictured: (D) (F)

(D) Counter with Top Ledge

Dimensions: 62¹/₂"L x 23"D x 43¹/₂"H. Features: This five foot counter has the top mounted service surface ledge. Has a 7" register drop, two adjustable shelves, and openings for wire management for two computers.

W-S4R \$945.00

(C) Showcase

Dimensions: 36"L x 20"D x 38"H. Features: Has a 12"H vision case with solid sliding doors to enclose showcase and storage area. Includes one adjustable melamine shelf for storage space.

W-3SS \$389.00



Only \$1458⁰⁰
 Components pictured: (F) (E) (B)

(E) Counter with Front Ledge

Dimensions: 60"L x 27³/₄"D x 42"H. Features: This sleek counter has a laminated service surface ledge extending from the front of counter giving it a more contemporary look. Comes with two adjustable shelves, a 6"H register drop from top of counter, & wire management openings for two computers.

W-M4C \$990.00

(F) Side Showcase

Dimensions: 24"L x 18"D x 38"H. Features: 26"H Full Vision Showcase with one adjustable glass shelf. Melamine sides and solid sliding doors in back.

W-TCS \$289.00

ACTIVATION CENTERS



Only \$678⁰⁰
 Components pictured: (A) (B)

(A) Activation Counter with Front Ledge

Dimensions: 30"L x 26³/₄"D x 42"H. Features: This sleek activation counter has a uniquely oblong front mounted service surface ledge. It includes openings for wire management, one adjustable shelf, and a 6" register drop.

W-M2C \$389.00

(B) Side Showcase

Dimensions: 24"L x 18"D x 38"H. Features: 26"H Full Vision Showcase with one adjustable glass shelf. Melamine sides and solid sliding doors in back.

W-TCS \$289.00



Only \$1167⁰⁰
 Components pictured: (A) (C) (A)



Only \$1167⁰⁰
 Components pictured: (A) (D) (A)

(C) Angled Showcase

Dimensions: 37³/₄"/26¹/₂"L x 18"D x 38"H. Features: 34"H Full Vision Showcase with two adjustable glass shelves. Melamine sides and solid sliding doors in back. Ideal to fit between two register stands to form an angled customer service area.

W-ACS \$389.00

(D) Angled Merchandiser

Dimensions: 32"/24"L x 18"D x 38"H. Features: 4" x 4" square grooved slatwall for an intense look with full merchandising capabilities. The perfect area to merchandise last minute sale add ons and accessories.

W-ACS \$389.00



Pictured unit includes:
 • (2) Aluminum Framed Showcase (W-AAS),
 • (1) Counter with Front Ledge (W-M4C)

Only \$2780⁰⁰
 Components pictured: (F) (E) (F)

(E) Counter with Front Ledge

Dimensions: 60"L x 27³/₄"D x 42"H. Features: This sleek counter has a laminated service surface ledge extending from the front of counter giving it a more contemporary look. Comes with two adjustable shelves, a 6"H register drop from top of counter, & wire management openings for two computers.

W-M4C \$990.00

(F) Aluminum Framed Showcase

Dimensions: 32"L x 18"D x 38"H. Features: The ultimate in showcase vision since your product can be viewed from all angles. Constructed of heavy duty aluminum framed glass. Bottom base includes sliding doors with ample open storage.

W-AAS \$895.00

Optional Add Ons:

Choose these add-ons to optimize the look and functionality of your store!

Add Lights to any Showcase:
 + \$175.00

Add a Lock to any Showcase:
 + \$35.00

Add Mirror Doors:
 + \$55.00

Add a Drawer to any counter:
 + \$55.00

Mix and match components to meet your budget and your style!

TABLES & COUNTERS



Double Wall Unit

Dimensions: 66"L x 18"D x 36"H. Features: This double wall unit comes with two triple phone holders. Unit is pre-drilled for phone holder attachment. See accessories for complete description on phone holders. **W-2W6P \$557.00**



Triple Wall Unit

Dimensions: 86"L x 18"D x 36"H. Features: This triple wall unit comes with three triple phone holders. Unit is pre-drilled for phone holder attachment. See accessories for complete description on phone holders. **W-3W9P \$655.00**



Center Double-Sided Floor Unit

Dimensions: 60"L x 20"D x 36"H. Features: This double sided floor unit has four, triple phone holders. Table is divided by a 4" center lip down the middle of the table. Unit is pre-drilled for phone holder attachment. **W-F12P \$695.00**

Wall Storage Credenza

Dimensions: 60"L x 18"D x 38"H. Features: Ideal unit to store inventory behind activation center. Unit includes two storage areas each with one adjustable shelf. Unit does not include lock. **W-5WSC \$595.00**



Round Table

Dimensions: 36"Diam. x 29"H. Features: This 1/2" thick round table is ideal for customer waiting or new activation consultations. Has black metal legs. **W-RCT \$245.00**



See our different finish options on back cover!

MERCHANDISERS

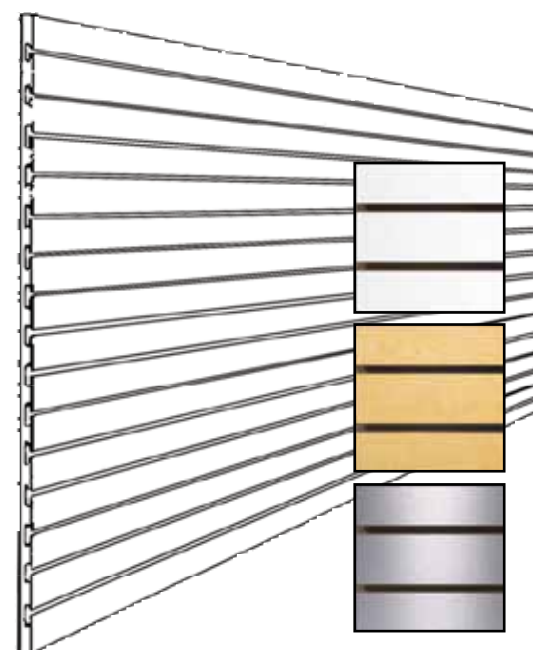

Slatwall Panels

Dimensions: 8'L x 4'H. Features: High Quality Low Pressure Melamine slatwall with 3" on-center grooves.

2001	Ready to Paint	\$42.50
2750	Goshen White	\$59.00
2687	Hard Rock Maple	\$60.00
2738	Brushed Aluminum	\$89.00

Large Floating Slatwall Panel

Dimensions: 39"L x 1 1/2"D x 80"H. Features: This panel is mounted off the wall to give a "floating" effect. Panel is completely framed, grooves are non-finished.

W-WS1 \$198.00



Tri Panel Slatwall Ensemble

Features: Two outside panels 25"L x 1 1/2"D x 62"H have 6" on-center grooved slatwall. Center panel is 38"L x 1 1/2"D x 62"H has 3" on-center grooved slatwall. Panels are mounted off the wall to give a "floating" effect. Panels are completely framed, grooves are non-finished.

W-TPSE \$545.00

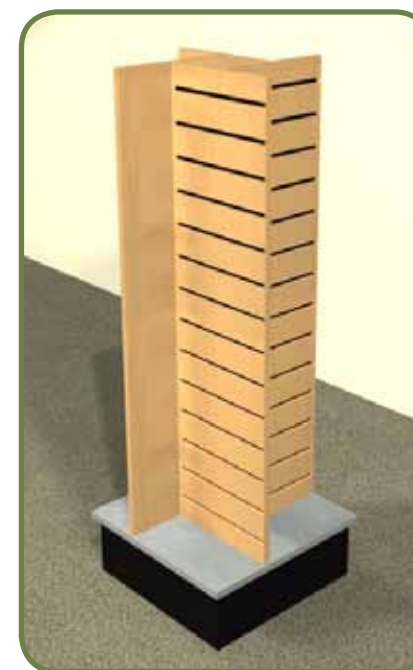

Stationary 4-Way Pinwheel

Dimensions: 22"L x 22"D x 54"H. Features: This stationary slatwall pinwheel has four merchandising areas of 14"L x 47"H, 3" on-center slatwall. It sits on a 7"H base.

W-RWS \$295.00

Rotating 4-Way Pinwheel

Dimensions: 22"L x 22"D x 60"H. Features: This pinwheel has four slatwall merchandising areas of 13 1/4"L x 36"H sitting on a round rotator that sits on an 11"H base. Slatwall is 3" on-center with non-finished grooves. Includes signage block on top that measures 8 1/4" Square x 3"H

W-RWRU-1 \$565.00



ACCESSORIES

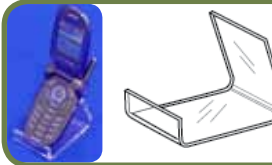

Easel Display
2"H x 2"W x 3"D
W-151081 \$2.50



Riser Easel Display
For smaller devices.
5"H x 2 1/2"W x 5"D
CPEE \$7.95
For larger devices.
5 1/4"H x 3 3/4"W x 5"D
CPBH \$8.95



Countertop Phone Display
For smaller devices.
5 1/4"H x 2 3/4"W x 5"D
CP3 \$8.50
For larger devices.
5 1/4"H x 3 1/4"W x 5 1/2"D
CP3W \$9.25



Hand Shaped Displays
For smaller devices.
5"H x 3"W x 2 3/4"D
CPH2 Clear \$6.95
Colors \$7.50
For larger devices.
6"H x 4"W x 3 1/2"D
CPH Clear \$10.50
Colors \$12.75

*Available colors:
Blue (B), Green (G),
& Red (R) [appears
fluorescent pink]



Slatwall Phone Display
For smaller devices.
6"H x 2 1/4"W x 1 1/4"D
ZCP2 \$6.25
For larger devices.
8"H x 3"W x 2"D
ZCP3 \$9.75



Slatwall Hooks
Available in Chrome (XTW),
White (EVH) or Black (EBL)
(Color)/H1 1" \$0.62
(Color)/H4 4" \$0.63
(Color)/H6 6" \$0.68
(Color)/H8 8" \$0.75
(Color)/H10 10" \$0.79
(Color)/H12 12" \$0.89



Duron Shelves
Lightweight yet strong and durable.
Molded to have a thick, heavy look.
Available in Black (B), White (W), Grey (G),
Almond (A), Light Maple (AL/FIN3-HM)
or Black with Mahogany Bullnose (B/
FIN2-MHY)
DA224/(Finish) 13"D x 24"L \$13.95
DA248/(Finish) 13"D x 48"L \$22.95
*Light Maple and Mahogany Bullnose shelves add
\$19.50



Phone Pedestals
Acrylic displays exhibit wireless
devices at a perfect angle for
consumer viewing.
W-111346 4"H \$4.25
W-111347 5"H \$5.25
W-111348 6"H \$5.75
W-111349 Set of 3 \$14.25



Round Multi Display
9" Diameter circular base with four
cradles at 3"H, 4"H, 5"H & 6"H.
W-111392 \$19.95



Boomerang Display
11"H x 12"W x 7"D. Has five
cradles from 3"H to 9"H.
W-111399 \$22.95



Metal Phone Holder
Silver, 20"L x 10"H x 8"D powder-
coated, heavy-duty metal display.
Includes three wireless device holders
that can be removed/adjusted on a
rail system. Each holder is 7"H x 4"W
with a 1" lip and opening for use with
security retractor. Includes three 5"H x
4"W acrylic sign holder that mount on
top of each holder.
W-CPD \$89.50
5"H x 4"W Acrylic Replacement
W-MHAR \$4.75



Security Retractors
2 1/2"H x 1 3/4"W x 8 1/2"D casing with
30" cable reach and flexible cable
end. Includes adhesives to apply the
retractor to secure surface and to
apply end to wireless device.
B55B \$9.95



Slatwall Brackets
Available in Chrome (XTW),
White (EVH) or Black (EBL)
(Color)/8KB 8" \$2.75
(Color)/10KB 10" \$2.95
(Color)/12KB 12" \$3.25
(Color)/14KB 14" \$3.50

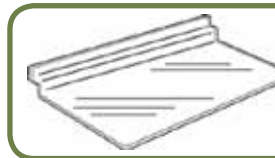

Small Acrylic Shelf
4"W x 10"L
JM410/ST \$2.00

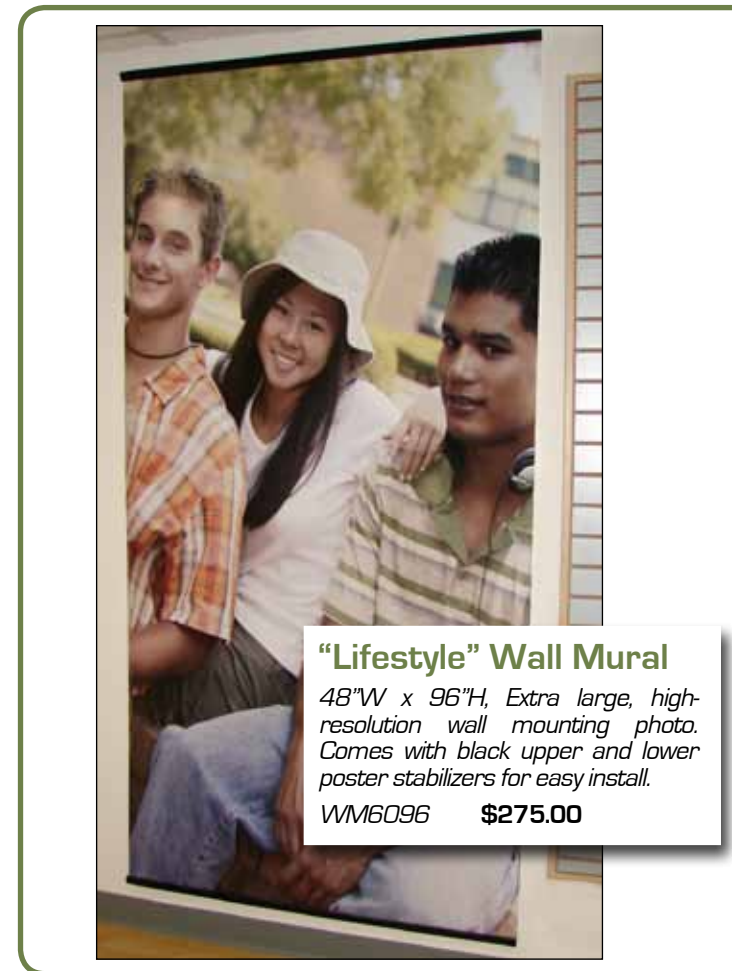

"Lifestyle" Wall Mural
48"W x 96"H, Extra large, high-
resolution wall mounting photo.
Comes with black upper and lower
poster stabilizers for easy install.
WM6096 \$275.00



Poster Holder
Made of black, durable PVC. Top loading
slit allows signs to slide in-and-out easily.
For 24"W x 36"H media.
W-PH \$46.00

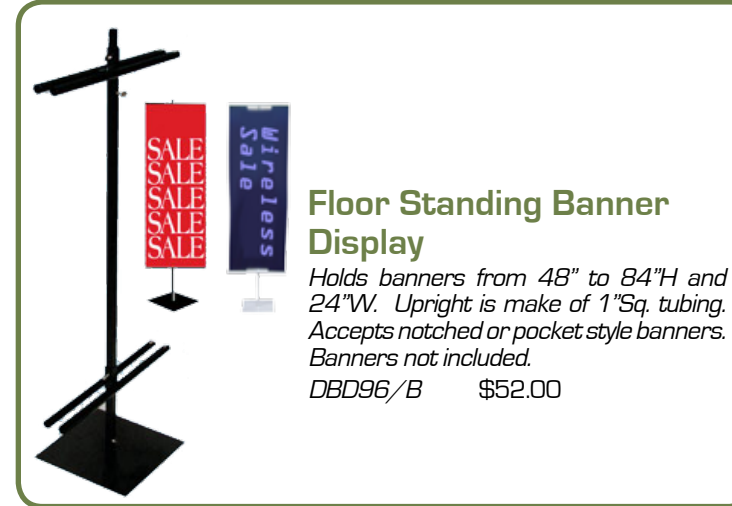

**Floor Standing Banner
Display**
Holds banners from 48" to 84"H and
24"W. Upright is made of 1"Sq. tubing.
Accepts notched or pocket style banners.
Banners not included.
DBD96/B \$52.00

ACCESSORIES

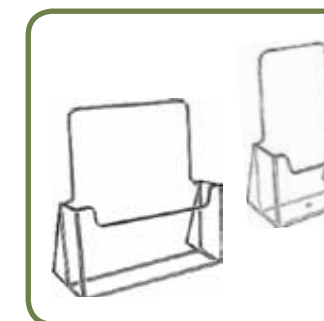

**Countertop
Brochure Holders**
Acrylic.
For 4" x 9" literature
B1E \$2.95
For 8 1/2" x 11" literature
B2E \$4.95

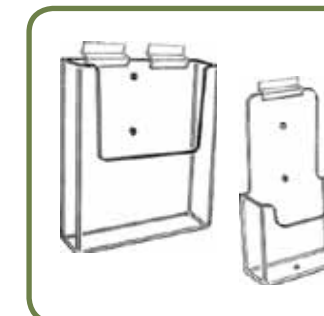

**Slatwall
Brochure Holders**
Acrylic.
For 4" x 9" literature
ZB1WE \$2.95
For 8 1/2" x 11" literature
ZB2WE \$4.95



**Countertop Acrylic
Sign Holders**
For 5 1/2" W x 7"H signs
Slant back 1221N \$2.95
Two-sided 1215N \$3.50
For 8 1/2"W x 11"H signs
Slant back MA8511 \$6.50
Two-sided MB8511 \$8.50

*many other sizes available, call to inquire.

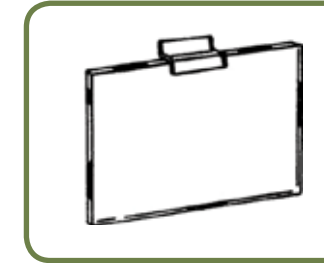

Slatwall Signholders
Acrylic.
ZM3520 3 1/2"W x 2"H \$2.95
ZM5535 5 1/2"W x 3 1/2"H \$3.25
ZM7055 7"W x 5 1/2"H \$4.25
ZM8511 8 1/2"W x 11"H \$7.95
ZM1185 11"W x 8 1/2"H \$7.95



**Aluminum Double
Sided Poster Holder**
Indoor/Outdoor A-Board made of
anodized aluminum. Has easy-to-
use "snap" profiles to easily insert
media. Includes anti-reflective
PVC sheets to protect media. For
24"W x 36"H media.
EASEL-137 \$215.00

FINISH OPTIONS



Finish Option 1

Maple and Brushed Aluminum look with Black Accent.

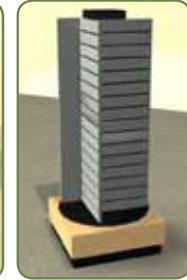

Finish Option 2

Maple and Brushed Aluminum look with Red Accent.

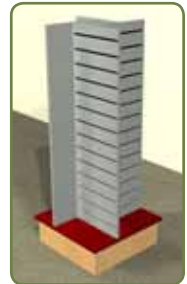
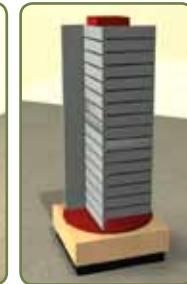

Finish Option 3

Black and Brushed Aluminum look with Burnt Orange Accent.

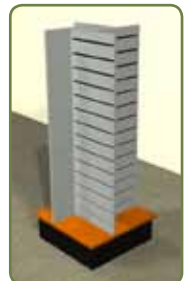

This is Ram Fixture's stock wireless fixture program. If these fixtures don't suit your look, style or preferences; we can custom manufacture to fit any existing needs or generate a new design to brand your own look. Please call us for more information.